

PUNCH®

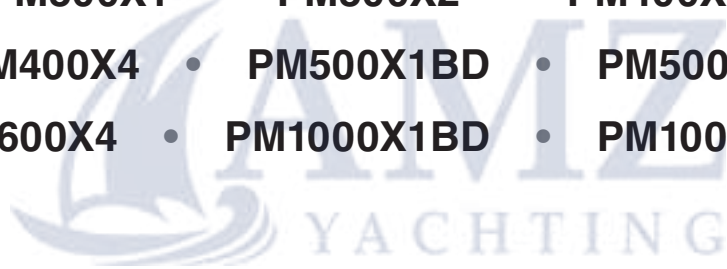

PM300X1 • PM300X2 • PM400X2
PM400X4 • PM500X1BD • PM500X2
PM600X4 • PM1000X1BD • PM1000X5



Introduction

Dear Customer,

Congratulations on your purchase of the world's finest brand of car audio products. At Rockford Fosgate we are fanatics about musical reproduction at its best, and we are pleased you chose our product. Through years of engineering expertise, hand craftsmanship and critical testing procedures, we have created a wide range of products that reproduce music with all the clarity and richness you deserve.

For maximum performance we recommend you have your new Rockford Fosgate product installed by an Authorized Rockford Fosgate Dealer, as we provide specialized training through Rockford Technical Training Institute (RTTI). Please read your warranty and retain your receipt and original carton for possible future use.

Great product and competent installations are only a piece of the puzzle when it comes to your system. Make sure that your installer is using 100% authentic installation accessories from Rockford Fosgate in your installation. Rockford Fosgate has everything from RCA cables and speaker wire to power wire and battery connectors. Insist on it! After all, your new system deserves nothing but the best.

To add the finishing touch to your new Rockford Fosgate image order your Rockford accessories, which include everything from T-shirts to jackets.

Visit our web site for the latest information on all Rockford products; www.rockfordfosgate.com or, in the U.S. call 1-800-669-9899 or FAX 1-800-398-3985. For all other countries, call +001-480-967-3565 or FAX +001-480-966-3983.

Table of Content

2	Introduction
3	Specifications
4-5	Design Features
6-17	Installation
	Installation Considerations
	Mounting Locations
	Battery and Charging
	Wiring the System
18-19	Operation
	Clip Indicator Setup
	Adjusting Crossover Frequency
	2/4 Channel Switch
	Subwoofer Input Switch
	Infrasonic Filter
	Punch EQ
20	Troubleshooting
21	Limited Warranty Information

If, after reading your manual, you still have questions regarding this product, we recommend that you see your Rockford Fosgate dealer. If you need further assistance, you can call us direct at **1-800-669-9899**. Be sure to have your serial number, model number and date of purchase available when you call.

PRACTICE SAFE SOUND

Continuous exposure to sound pressure levels over 100dB may cause permanent hearing loss. High powered auto sound systems may produce sound pressure levels well over 130dB. Use common sense and practice safe sound.

Safety

This symbol with "WARNING" is intended to alert the user to the presence of important instructions. Failure to heed the instructions will result in severe injury or death.



WARNING

This symbol with "CAUTION" is intended to alert the user to the presence of important instructions. Failure to heed the instructions can result in injury or unit damage.



CAUTION

- To prevent injury and damage to the unit, please read and follow the instructions in this manual. We want you to enjoy this system, not get a headache.
- If you feel unsure about installing this system yourself, have it installed by a qualified Rockford Fosgate technician.
- Before installation, disconnect the battery negative (-) terminal to prevent damage to the unit, fire and/or possible injury.

Mode	PM300X2	PM400X2	PM500X2	PM400X4	PM600X4	PM1000X5	PM300X1	PM500X1bd	PM1000X1bd
Rated Power - Continuous Power Rating (RMS) Measured @ 14.4V	100x2 @ 4 ohms 150x2 @ 2 ohms 300x1 @ 4 ohms*	125x2 @ 4 ohms 200x2 @ 2 ohms 400x1 @ 4 ohms*	150x2 @ 4 ohms 250x2 @ 2 ohms 500x1 @ 4 ohms*	50x4 @ 4 ohms 100x4 @ 2 ohms 200x2 @ 4 ohms*	75x4 @ 4 ohms 150x4 @ 2 ohms 300x2 @ 4 ohms*	75x4 @ 4 ohms 125x4 @ 2 ohms 250x2 @ 4 ohms* Sub: 150x1 @ 4 ohms 300x1 @ 2 ohms 500x1 @ 1 ohm	200x1 @ 4 ohms 300x1 @ 2 ohms	150x1 @ 4 ohms 300x1 @ 2 ohms 500x1 @ 1 ohms	300x1 @ 4 ohms 600x1 @ 2 ohms 1000x1 @ 1 ohms
Crossover Slope	12 dB/Oct	12 dB/Oct	12 dB/Oct	12 dB/Oct	12 dB/Oct	12 dB/Oct	12 dB/Oct	12 dB/Oct	12 dB/Oct
Crossover Frequency	Variable 50Hz-250Hz	Variable 50Hz-250Hz	Variable 50Hz-250Hz	Variable 50Hz-250Hz	Variable 50Hz-250Hz	Variable 50Hz-250Hz Sub: 28Hz	Variable 50Hz-250Hz	Variable 50Hz-250Hz Sub: 28Hz	Variable 50Hz-250Hz Sub: 28Hz
Punch EQ	Variable 0 - +14dB @ 12.5kHz and 0 - -18dB @ 45Hz	Variable 0 - +14dB @ 12.5kHz and 0 - -18dB @ 45Hz	Variable 0 - +14dB @ 12.5kHz and 0 - -18dB @ 45Hz	Variable 0 - +14dB @ 12.5kHz and 0 - -18dB @ 45Hz	Variable 0 - +14dB @ 12.5kHz and 0 - -18dB @ 45Hz	Variable 0 - +14dB @ 12.5kHz and 0 - -18dB @ 45Hz	Variable 0 - +14dB @ 12.5kHz and 0 - -18dB @ 45Hz	Variable 0 - +18dB @ 45Hz	Variable 0 - +18dB @ 45Hz
Operating Voltage	9-16VDC	9-16VDC	9-16VDC	9-16VDC	9-16VDC	9-16VDC	9-16VDC	9-16VDC	9-16VDC
Frequency Response	20Hz-20kHz	20Hz-20kHz	20Hz-20kHz	20Hz-20kHz	20Hz-20kHz	20Hz-20kHz	20Hz-20kHz	20Hz-250Hz	20Hz-250Hz
Battery Fuse Rating (not supplied)	50A	60A	80A	60A	100A	150A	50A	80A	140A
THD+N @ Rated Power	<1.0% @ 4 ohms <1.0% @ 2 ohms	<1.0% @ 4 ohms <1.0% @ 2 ohms	<1.0% @ 4 ohms <1.0% @ 2 ohms	<1.0% @ 4 ohms <1.0% @ 2 ohms	<1.0% @ 4 ohms <1.0% @ 2 ohms	FR: <1.0% @ 4 ohms <1.0% @ 2 ohms Sub: <1.0% @ 4 ohms <1.0% @ 2 ohms <1.0% @ 1 ohm	<1.0% @ 4 ohms <1.0% @ 2 ohms <1.0% @ 1 ohm	<1.0% @ 4 ohms <1.0% @ 2 ohms <1.0% @ 1 ohm	<1.0% @ 4 ohms <1.0% @ 2 ohms <1.0% @ 1 ohm
Input Sensitivity	150mV-12V	150mV-12V	150mV-12V	150mV-12V	150mV-12V	150mV-12V	150mV-12V	150mV-12V	150mV-12V
Input Impedance	20k	20k	20k	20k	20k	20k	20k	20k	20k
S/N Ratio CTA 2006	>85dB	>85dB	>85dB	>85dB	>85dB	FR: > 85dB Sub: >80dB	>85dB	>80dB	>80dB
S/N Ratio @ Rated Power	>105dB	>105dB	>105dB	>105dB	>105dB	FR: >105dB Sub: >100dB	>105dB	>100dB	>100dB
Channel Separation	>50dB	>50dB	>50dB	>50dB	>50dB	>50dB	N/A	N/A	N/A
Common Mode Rejection Ratio	>55dB	>55dB	>55dB	>55dB	>55dB	>55dB	>55dB	>55dB	>55dB
Damping Factor	>500	>500	>500	>500	>500	FR: >500 Sub: >300	>500	>300	>300
Dimensions (LxWxH)	9.9" x 7.8" x 2.4" (25cm x 19.7cm x 6.1 cm)	11" x 7.8" x 2.4" (28cm x 19.7cm x 6.1 cm)	13.3" x 7.8" x 2.4" (33.7cm x 19.7cm x 6.1 cm)	11" x 7.8" x 2.4" (28cm x 19.7cm x 6.1 cm)	13.3" x 7.8" x 2.4" (33.7cm x 19.7cm x 6.1 cm)	15" x 7.8" x 2.4" (38.2cm x 19.7cm x 6.1 cm)	9.9" x 7.8" x 2.4" (25cm x 19.7cm x 6.1 cm)	11" x 7.8" x 2.4" (28cm x 19.7cm x 6.1 cm)	13.3" x 7.8" x 2.4" (33.7cm x 19.7cm x 6.1 cm)

CTA 2006

Power ratings on Rockford Fosgate amplifiers conform to CTA-2006 industry standards. These guidelines mean your amplifiers' output power ratings are REAL POWER numbers, not inflated marketing ratings.

* Rated power when amplifier is wired in a bridged configuration.



Power/Protect LED

Power LED illuminates blue when the unit is turned on. Protect LED illuminates yellow if a short circuit or too low of an impedance is detected at the speaker connections. Thermal LED illuminates red when amplifier overheats. The amplifier will automatically shut down if this occurs.

Output Clip Indicator

The output clip indicator works in conjunction with the input level knob, illuminating to appropriate color depending on the audio content used for the setup.

Output Clip Indicator Chart

Reference chart for the output clip indicator LED illumination color during input level setup.

OUTPUT CLIP INDICATORS	
	MUSIC TEST TONE
BLUE	<input type="checkbox"/>
BLUE/RED	<input checked="" type="checkbox"/>
RED	<input type="checkbox"/>

*1kHz @ 0dB

Input Level Knob

The input level control is used to match the output of the audio source.

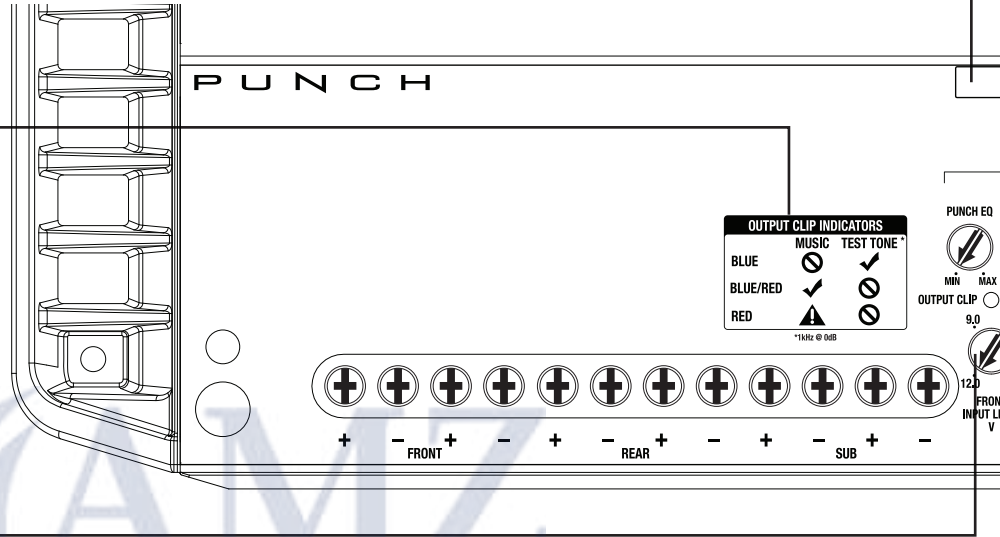

Subwoofer Input

Setting this switch to the "On" position, utilizes the "Sub" inputs. (PM1000X5)

Centering Indicators

Indicators are located on the bottom side of the amplifier.

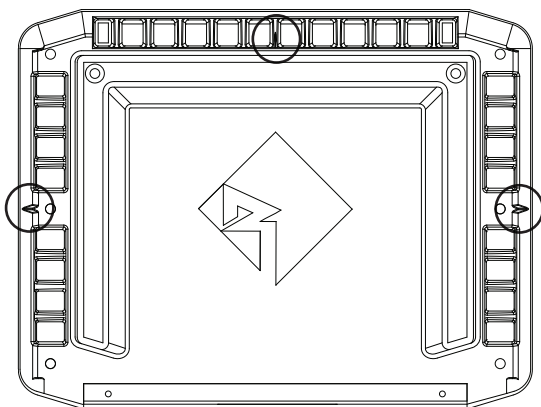
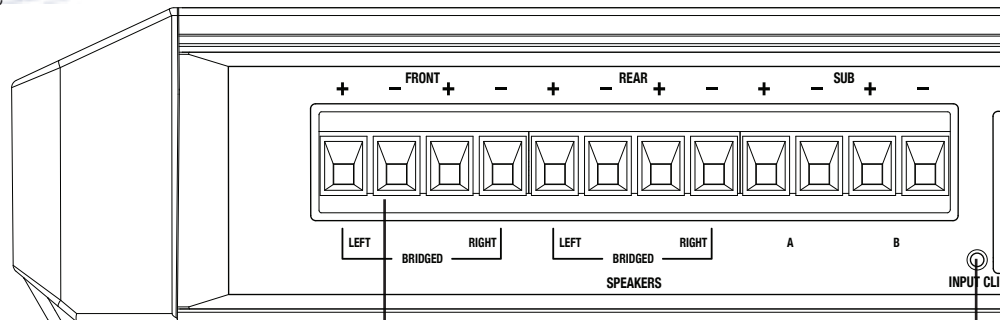

Speaker Terminals

The Speaker Terminals are nickel-plated captive c-clamp wire connectors (+ and -) will accommodate 8 AWG.

Input Clip Indicator

The input clip indicator works in conjunction with the audio source volume knob, illuminating red when audio source reaches its clipping point.

RCA Input/Pass-Thru

The RCA inputs are capable of accepting signal from either high-level (speaker) to low-level (RCA). When utilizing high-level for input signal the auto turn-on feature is active. The pass-thru RCA's are passive, including full input signal range and auto turn-on functionality when active.

Crossover Switch

Selectable switch for High-Pass (HP) or All Pass (AP) or Low-Pass (LP)

Variable Crossover

Is a built-in 12dB/octave Butterworth filter with a crossover point variable from 50Hz to 250Hz.

Punch EQ

A Gyrator based Punch EQ that eliminates frequency shift with boost. This works along with the crossover switch on the amplifier.

Infrasonic Filter

A fixed 28Hz 12dB/octave filter designed to prevent frequencies below the audio range from being applied to the subwoofer from the amplifier. Consequently improving subwoofer performance and power handling, particularly in vented enclosures. (PM500X1bd, P10001BD, PM1000X5)

Remote Punch Level Switch

When activated, this allows the use of an optional remote Punch Level Controller. (PM500X1bd, P10001BD, PM1000X5)

Remote Punch Level Control - In/Out

Remotely control the output level of the amplifier. The PLC-OUT is used to daisy-chain additional amplifiers controlled by a single remote.

Power/REM Terminals

The power and ground will accommodate 4 AWG, while the remote will accommodate 12 AWG. (The REM terminal is used to remotely turn-on and turn-off the amplifier when +12V DC is applied.)

2/4 Channel Switch

Setting this switch to the 2CH. position, switches the inputs to a 2-channel mode, allowing connection to only the front inputs with a 4-channel output. (PM400X4, PM600X4, PM1000X5)

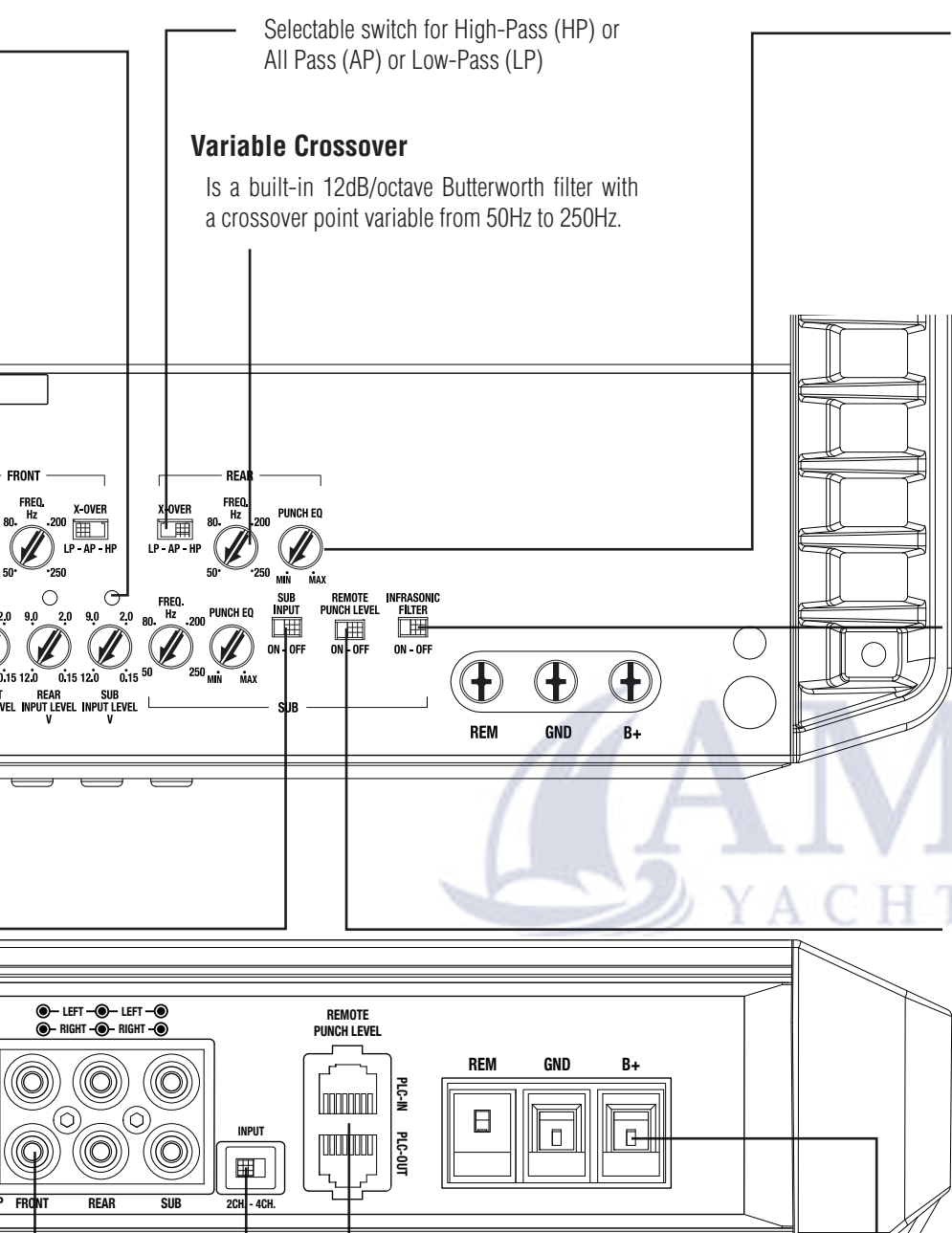

Installation

Contents

- Punch Amplifier
- Mounting Hardware
- Allen Wrench
- Quick Setup Guide
- Test tones available for download at https://rfttech.custhelp.com/app/answers/detail/a_id/1126/ Scroll to the bottom of the page and download your preferred format.

Installation Considerations

The following is a list of tools needed for installation:

- Fuse-holder and fuse. (See specifications for fuse rating)
- Volt/Ohm Meter
- Wire strippers
- Wire crimpers
- Wire cutters
- #2 Phillips screwdriver
- Battery post wrench
- Hand held drill w/assorted bits
- Assorted connectors
- Adequate Length—Red Power Wire
- Adequate Length—Remote Turn-on Wire
- Adequate Length—Black Grounding Wire

This section focuses on some of the vehicle considerations for installing your new amplifier. Pre-planning your system layout and best wiring routes will save installation time. When deciding on the layout of your new system, be sure that each component will be easily accessible for making adjustments.

⚠ CAUTION If you feel unsure about installing this system yourself, have it installed by a qualified technician.

⚠ CAUTION Before installation, disconnect the battery negative (-) terminal to prevent damage to the unit, fire and/or possible injury.

Before beginning any installation, follow these simple rules:

1. Be sure to carefully read and understand the instructions before attempting to install the unit.
2. For safety, disconnect the negative lead from the battery prior to beginning the installation.
3. For easier assembly, we suggest you run all wires prior to mounting your unit in place.
4. Route all of the RCA cables close together and away from any high current wires.
5. Use high quality connectors for a reliable installation and to minimize signal or power loss.

6. Think before you drill! Be careful not to cut or drill into gas tanks, fuel lines, brake or hydraulic lines, vacuum lines or electrical wiring when working on any vehicle.
7. Never run wires underneath the vehicle. Running the wires inside the vehicle provides the best protection.
8. Avoid running wires over or through sharp edges. Use rubber or plastic grommets to protect any wires routed through metal, especially the firewall.
9. ALWAYS protect the battery and electrical system from damage with proper fusing. Install the appropriate fuse holder and fuse on the +12V power wire within 18" (45.7 cm) of the battery terminal.
10. When grounding to the chassis of the vehicle, scrape all paint from the metal to ensure a good, clean ground connection. Grounding connections should be as short as possible and always be connected to metal that is welded to the main body, or chassis, of the vehicle. Seatbelt bolts should never be used for connecting to ground.

Mounting Locations

To ensure optimal performance, mount the amplifier with at least 1" (2.54cm) of air gap around the amplifier's heat sink to provide proper cooling.

Amplifier Centering Indicators

Centering indicators have been incorporated into the amplifier's heatsink to aid in the installation process.

Trunk Mounting

Mounting the amplifier vertically or inverted will provide adequate cooling of the amplifier. Mounting the amplifier on the floor of the trunk will provide the best cooling of the amplifier.

Passenger Compartment Mounting

Mounting the amplifier in the passenger compartment will work as long as you provide a sufficient amount of air for the amplifier to cool itself. If you are going to mount the amplifier under the seat of the vehicle, you must have at least 1" (2.54cm) of air gap around the amplifier's heat sink.

⚠ CAUTION Never mount this unit in the engine compartment. Mounting the unit in the engine compartment will void your warranty.

Battery and Charging

Amplifiers will put an increased load on the vehicle's battery and charging system. We recommend checking your alternator and battery condition to ensure that the electrical system has enough capacity to handle the increased load of your stereo system. Stock electrical systems which are in good condition should be able to handle the extra load of any Prime Series amplifier without problems, although battery and alternator life can be reduced slightly. To maximize the performance of your amplifier, we suggest the use of a heavy duty battery and an energy storage capacitor.

Wiring the System

CAUTION

If you do not feel comfortable with wiring your new unit, please see your local Authorized Rockford Fosgate Dealer for installation.

CAUTION

Before installation, disconnect the battery negative (-) terminal to prevent damage to the unit, fire and/or possible injury.

CAUTION

Avoid running power wires near the low level input cables, antenna, power leads, sensitive equipment or harnesses. The power wires carry substantial current and could induce noise into the audio system.

1. Plan the wire routing. Keep RCA cables close together but isolated from the amplifier's power cables and any high power auto accessories, especially electric motors. This is done to prevent coupling the noise from radiated electrical fields into the audio signal. When feeding the wires through the firewall or any metal barrier, protect them with plastic or rubber grommets to prevent short circuits. Leave the wires long at this point to adjust for a precise fit at a later time.
2. Prepare the RED wire (power cable) for attachment to the amplifier by stripping 1/2" of insulation from the end of the wire. Insert the bared wire into the B+ terminal and tighten the set screw to secure the cable in place.

NOTE: The B+ cable MUST be fused 18" or less from the vehicle's battery. Install the fuse holder under the hood and ensure connections are water tight.

3. Trim the RED wire (power cable) within 18" of the battery and splice in a inline fuse holder (not supplied). See Specifications for the rating of the fuse to be used. DO NOT install the fuse at this time.
4. Strip 1/2" from the battery end of the power cable and crimp an appropriate size ring terminal to the cable. Use the ring terminal to connect to the battery positive terminal.
5. Prepare the BLACK wire (Ground cable) for attachment to the amplifier by stripping 1/2" of insulation from the end of the wire. Insert the bare wire into the GROUND terminal and tighten the set screw to secure the cable in place. Prepare the chassis ground by scraping any paint from the metal surface and thoroughly clean the area of all dirt and grease. Strip the other end of the wire and attach a ring connector. Fasten the cable to the chassis using a non-anodized screw and a star washer.

NOTE: Keep the length of the BLACK wire (Ground) as short as possible. Always less than 30".

6. Prepare the Remote turn-on wire for attachment to the amplifier by stripping 1/2" of insulation from the end of the wire. Insert the bared wire into the REMOTE terminal and tighten the set screw to secure the wire in place. Connect the other end of the Remote wire to a switched 12 volt positive source. The switched voltage is usually taken from the

source unit's remote amp on lead. If the source unit does not have this output available, the recommended solution is to wire a mechanical switch in line with a 12 volt source to activate the amplifier.

NOTE: When utilizing high-level for input signal the auto turn-on feature is active. With the auto turn-on active, the REM becomes an output to turn on/off up to two additional amplifiers or other accessories.

7. Securely mount the amplifier to the vehicle or amp rack. Be careful not to mount the amplifier on cardboard or plastic panels. Doing so may enable the screws to pull out from the panel due to road vibration or sudden vehicle stops.
8. Connect from source signal by plugging into the RCA input jacks at the amplifier. The input sensitivity ranges from 150mV-12V to accommodate signal from either high-level(speaker) to low-level(RCA).

NOTE: All "ACTIVE" inputs must have RCA jacks connected. Switch in 2CH. position, "ACTIVE" - Front channel inputs only. Switch in 4CH. position, "ACTIVE" - All Front and Rear channel inputs. Switch in FRONT. position, "ACTIVE" - Front channel inputs only for sub output. Switch in SUB position, "ACTIVE" - Sub inputs for sub output. When connecting to the 5-Channel inputs, be sure to route front, rear and sub RCA cables tightly together.

CAUTION

Always ensure power is off or disconnected at the amplifier before connecting RCA cables. Failure to do so may cause damage to the amplifier and/or connected components.

9. Connect the speakers. Strip the speaker wires 1/2" and insert into the speaker terminal and tighten the set screw to secure into place. Be sure to maintain proper speaker polarity. DO NOT chassis ground any of the speaker leads as unstable operation may result.
10. Perform a final check of the completed system wiring to ensure that all connections are accurate. Check all power and ground connections for frayed wires and loose connections which could cause problems. Install inline fuse near battery connection.

NOTE: Follow the diagrams for proper signal polarity.

CAUTION

This amplifier is not recommended for impedance loads below 2-Ohm stereo/4-Ohm bridged for the multi-channel amplifiers and 1-ohm for mono amplifiers.

Installation

2-Channel (Stereo)

PM300X2, PM400X2, PM500X2

Source Unit

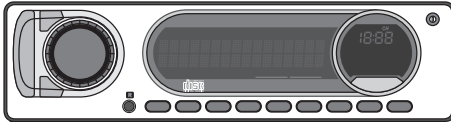

Switched 12V
to REM

PASS-THRU
Connect to inputs
of 2nd amplifier
*Installation option for
multi-amp install

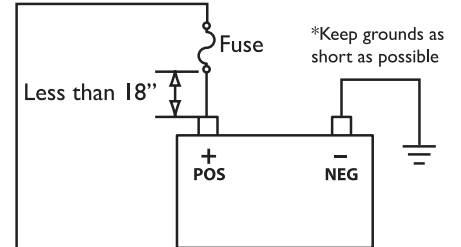
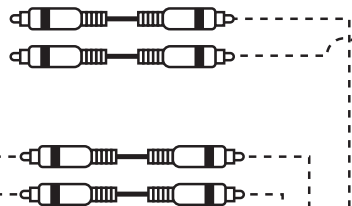

Amplifier

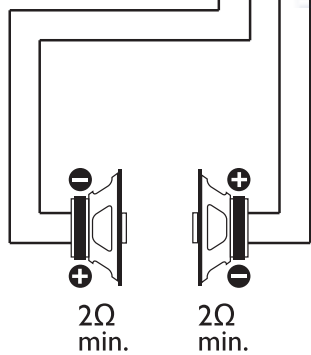
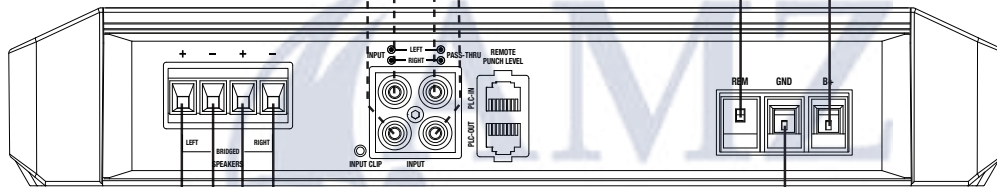

Connect to chassis
ground of vehicle

*Keep grounds as short
as possible

Optional Input Accessory

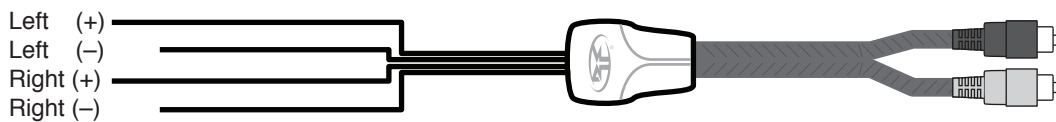

2-Channel (Mono)

PM300X2, PM400X2, PM500X2

Source Unit

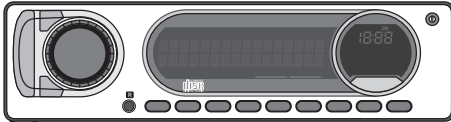

Switched 12V
to REM

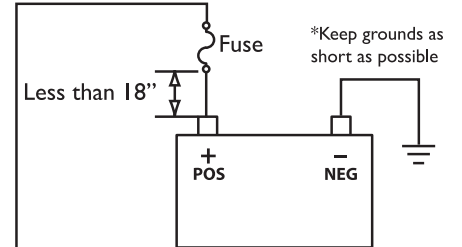

PASS-THRU
Connect to inputs
of 2nd amplifier
*Installation option for
multi-amp install

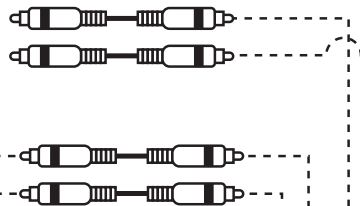

Amplifier

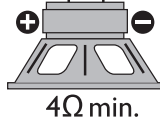
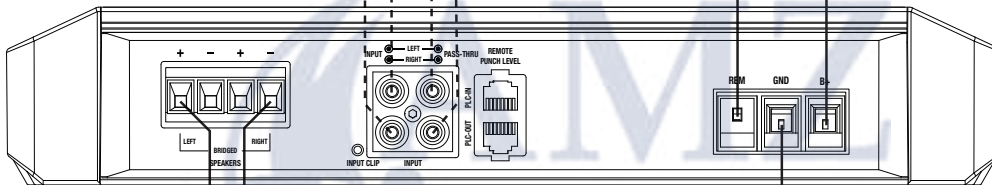

Connect to chassis
ground of vehicle
*Keep grounds as short
as possible

Optional Input Accessory

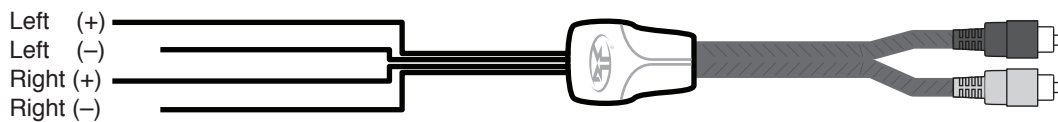

Installation

4-Channel (Stereo)

PM400X4, PM600X4

Source Unit

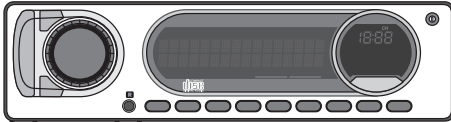

Switched 12V
to REM

PASS-THRU
Connect to inputs
of 2nd amplifier
*Installation option for
multi-amp install

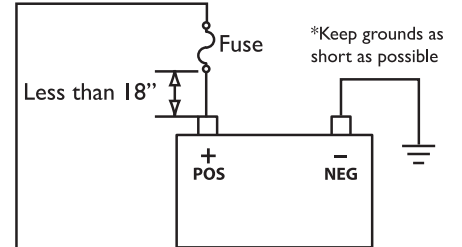

Amplifier

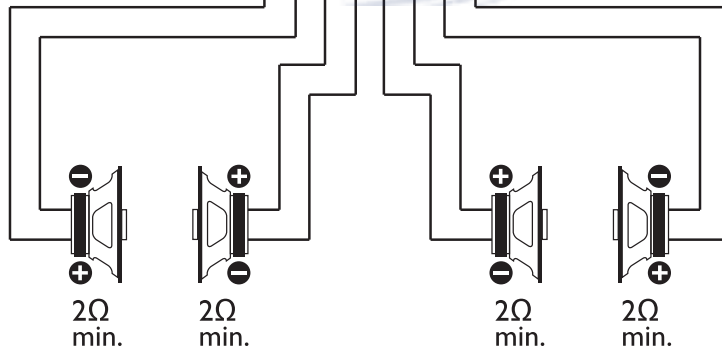
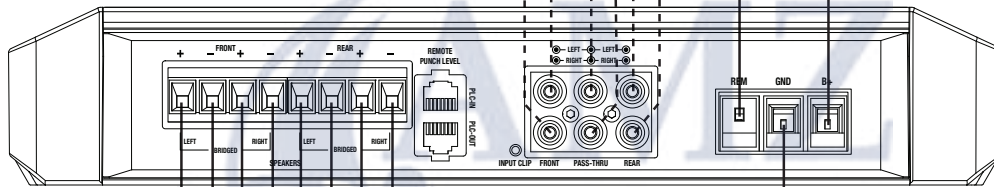

Connect to chassis
ground of vehicle

*Keep grounds as short
as possible

Optional Input Accessory

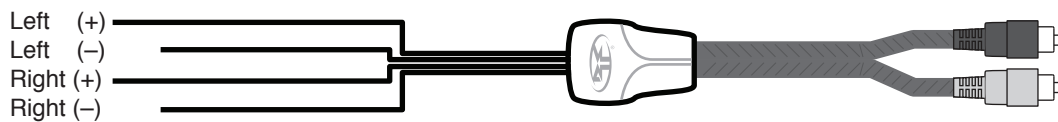

4-Channel (2ch Stereo & 1ch Mono-Bridged)

PM400X4, PM600X4

Source Unit

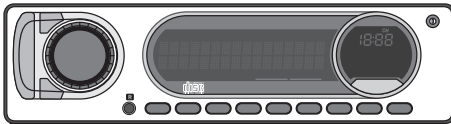

Switched 12V
to REM

PASS-THRU
Connect to inputs
of 2nd amplifier
*Installation option for
multi-amp install

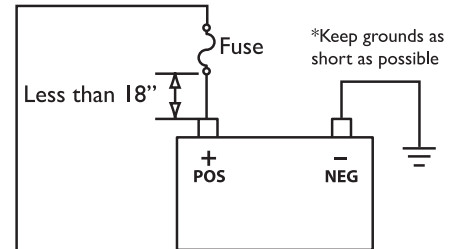

Amplifier

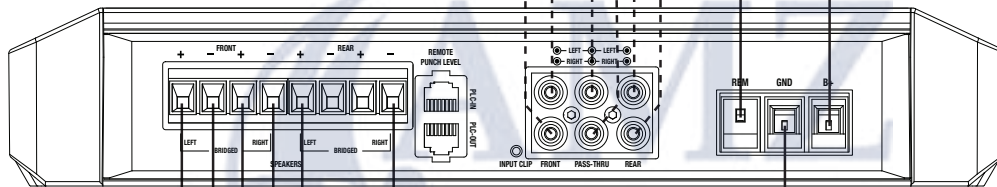

Connect to chassis
ground of vehicle

*Keep grounds as short
as possible

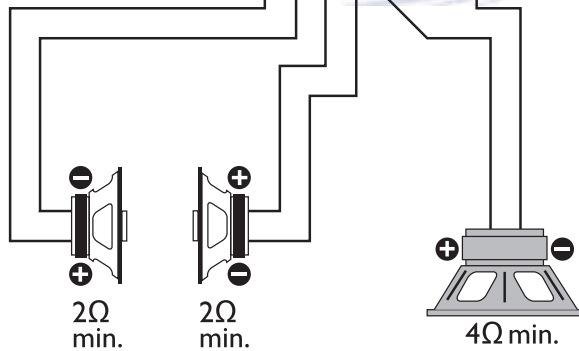

Optional Input Accessory

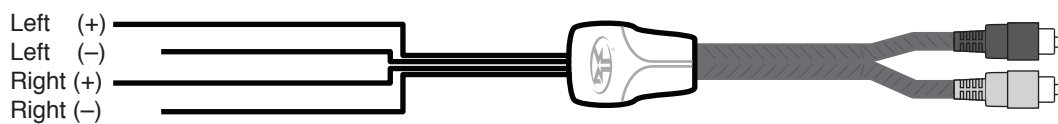

Installation

4-Channel (2ch Mono-Bridged)

PM400X4, PM600X4

Source Unit

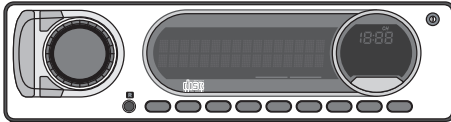

Switched 12V
to REM

PASS-THRU
Connect to inputs
of 2nd amplifier
*Installation option for
multi-amp install

Amplifier

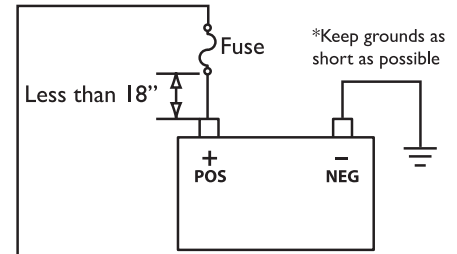
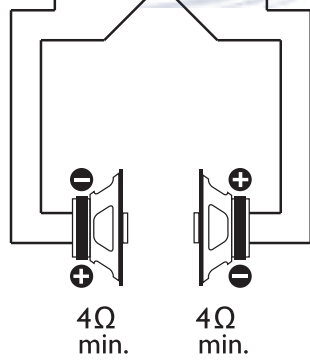
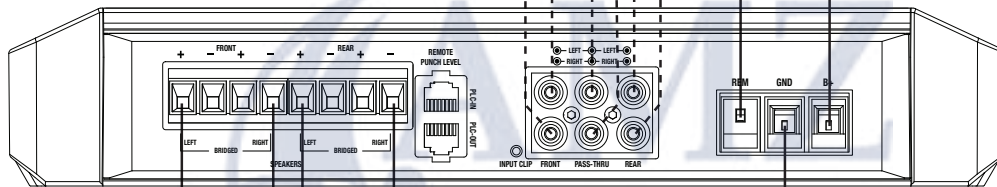

Less than 18"

Connect to chassis
ground of vehicle

*Keep grounds as short
as possible

Optional Input Accessory

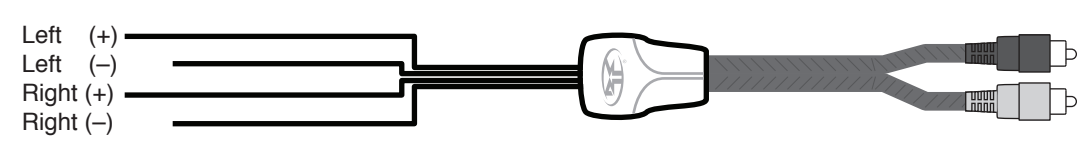

3-Channel (2ch bridged & 1ch Mono)

PM1000X5

Source Unit

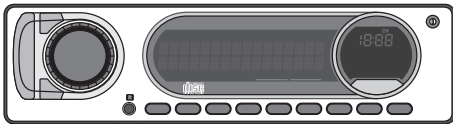

Switched 12V
to REM

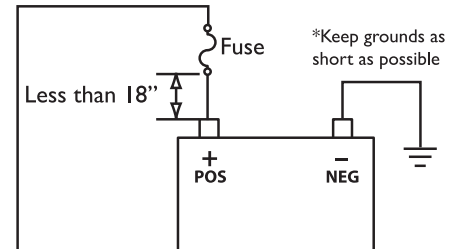
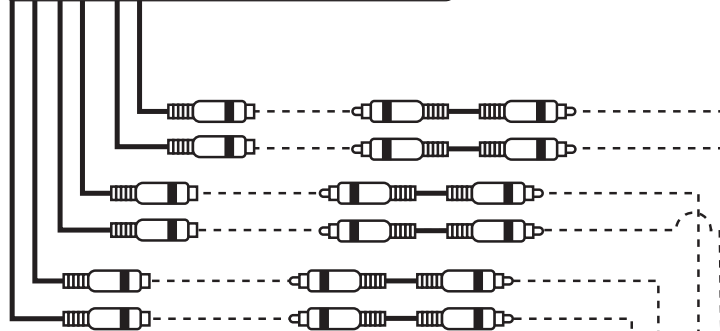

Less than 18"

Amplifier

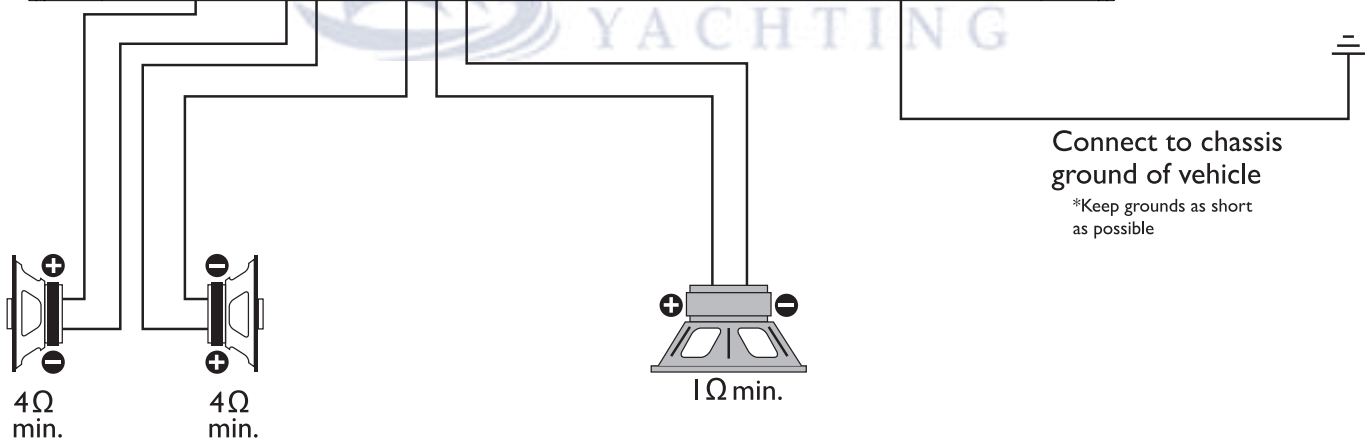
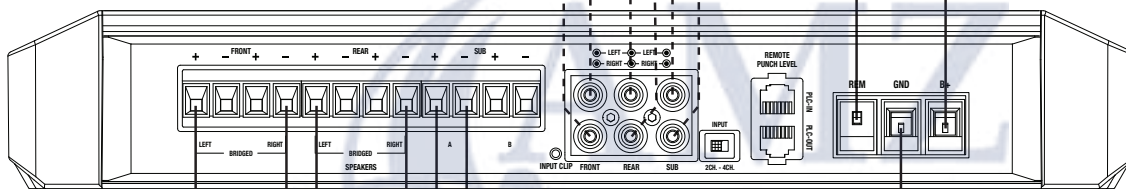

Connect to chassis
ground of vehicle

*Keep grounds as short
as possible

Optional Input Accessory

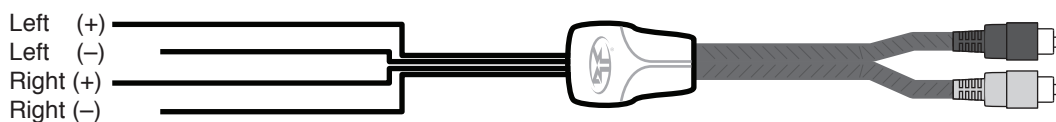

Installation

5-Channel (4ch Stereo & 1ch Mono)

PM1000X5

Source Unit

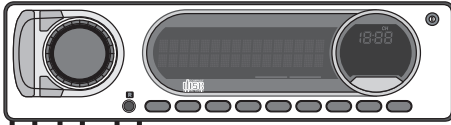

Switched 12V
to REM

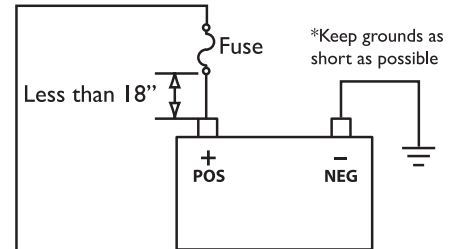

*Keep grounds as short as possible

Amplifier

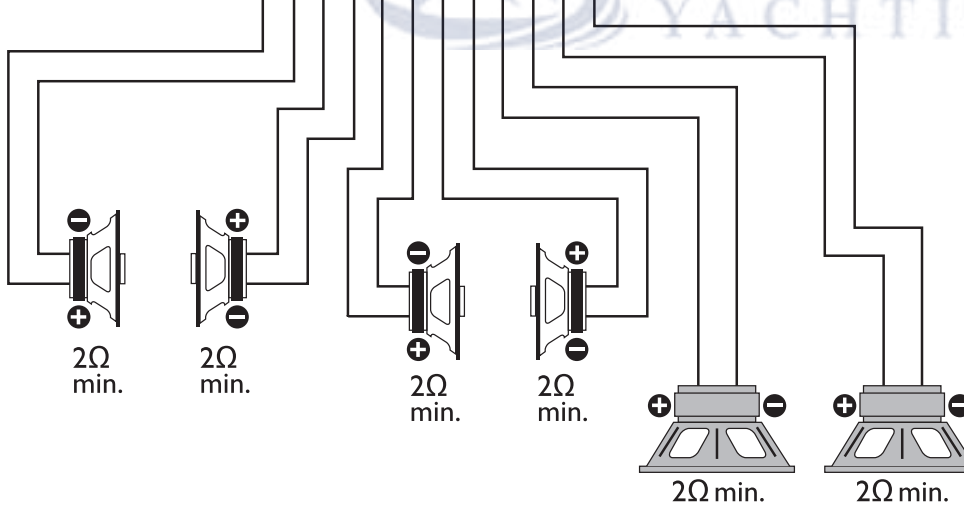
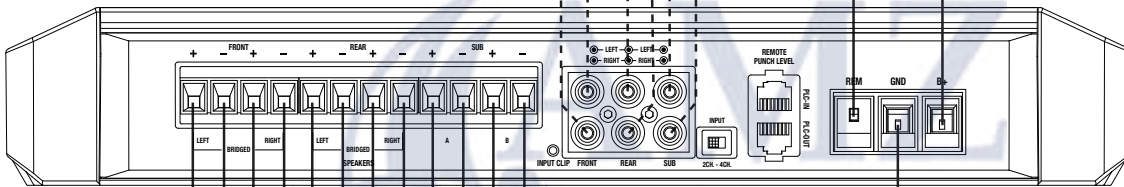

Connect to chassis
ground of vehicle

*Keep grounds as short as possible

*Positive(+) and Negative(-) outputs are wired in parallel internally.

Optional Input Accessory

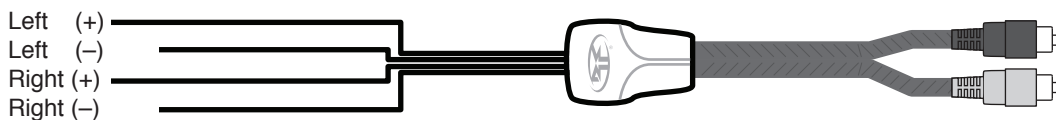

Parallel Wiring (Full Range Capable)

PM300X1

Source Unit

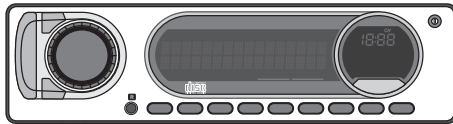

PASS-THRU
Connect to inputs
of 2nd amplifier
*Installation option for
multi-amp install

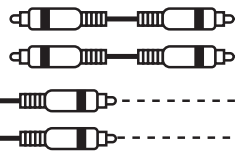

Switched 12V
to REM

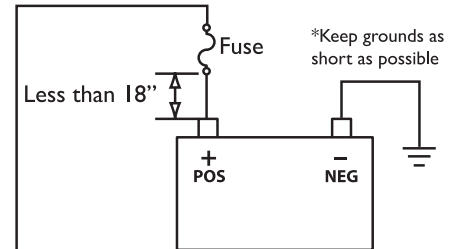

Amplifier

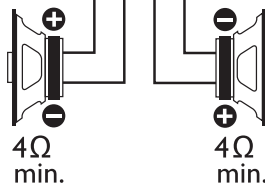
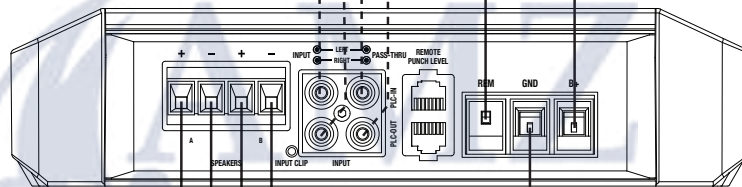

Connect to chassis
ground of vehicle

*Keep grounds as short
as possible

Optional Input Accessory

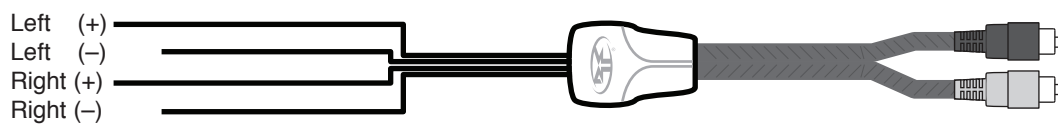

Installation

Mono Wiring

PM300X1, PM500X1bd, PM1000X1bd

Source Unit

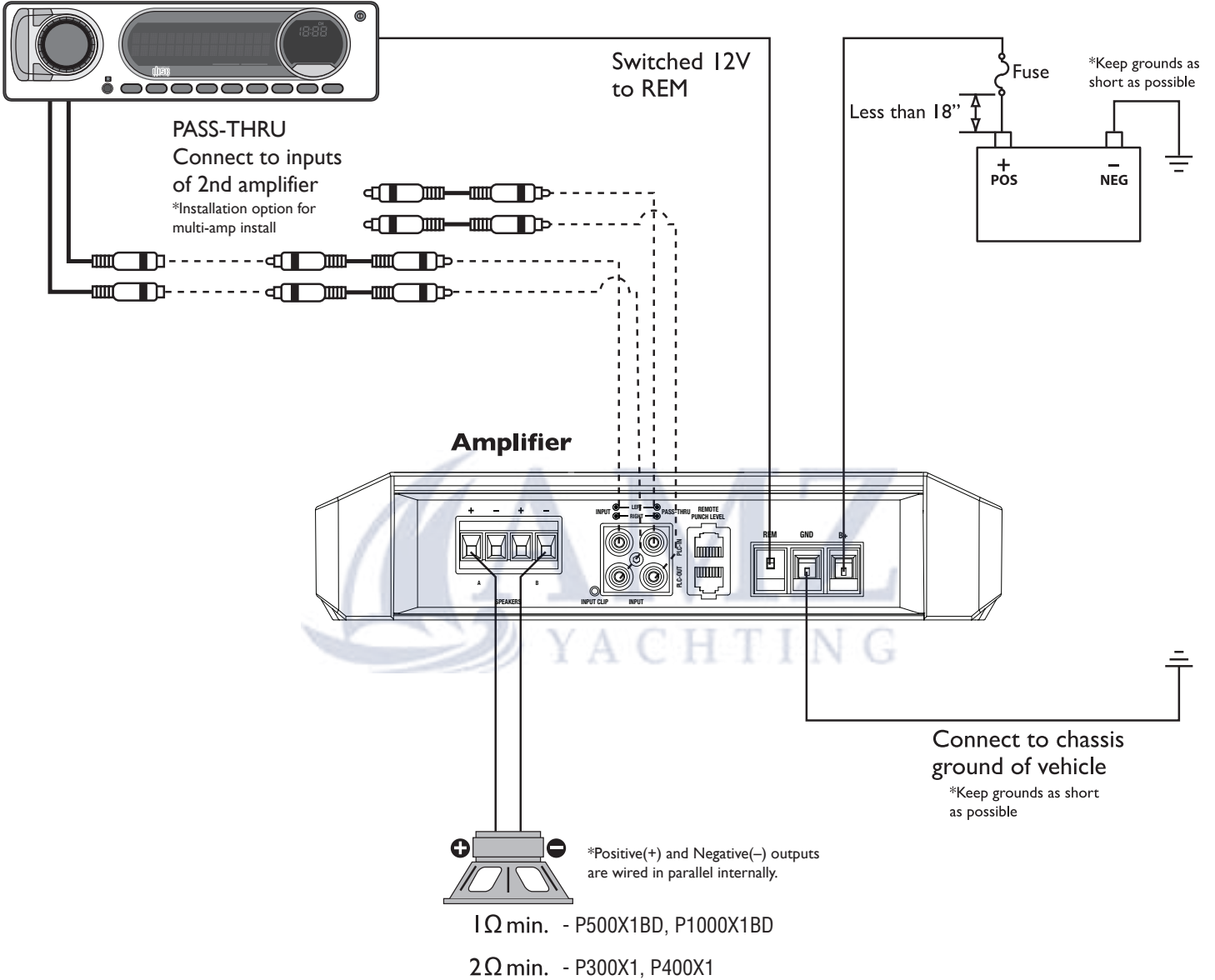

Optional Input Accessory

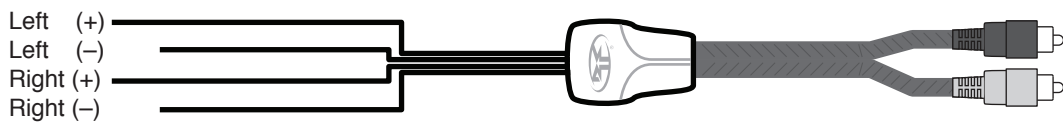

Parallel Wiring

PM500X1bd, PM1000X1bd

Source Unit

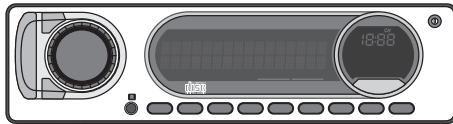

PASS-THRU
Connect to inputs
of 2nd amplifier
*Installation option for
multi-amp install

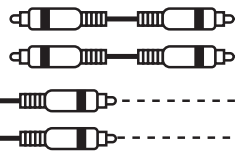

Switched 12V
to REM

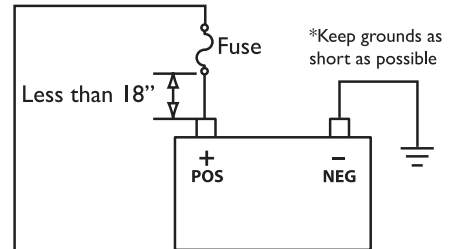

Amplifier

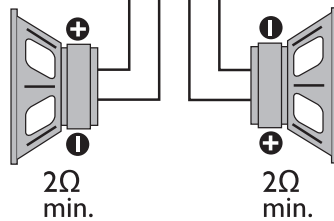
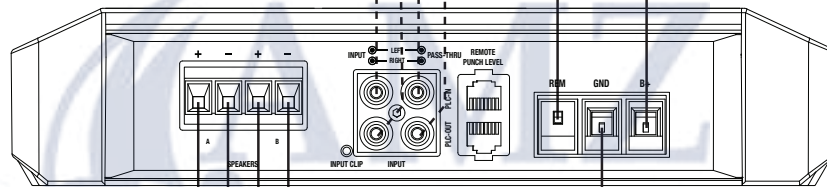

Connect to chassis
ground of vehicle

*Keep grounds as short
as possible

Optional Input Accessory

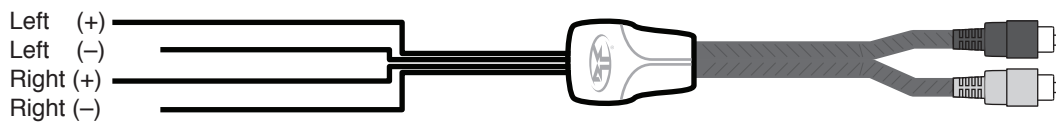

Operation

Input Clip Indicator Setup

Step 1. Be sure to disconnect all speakers from the amplifier.



illus.-3.1

CAUTION

Failure to comply may cause damage to connected components and/or amplifier.

Step 2. Turn on the source unit with volume set to zero.

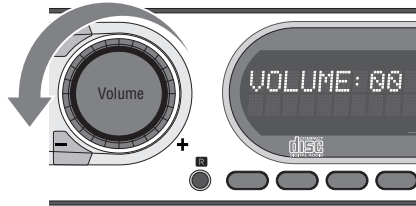

illus.-3.2

Step 3. Adjust the Bass & Treble levels on the source unit to flat.

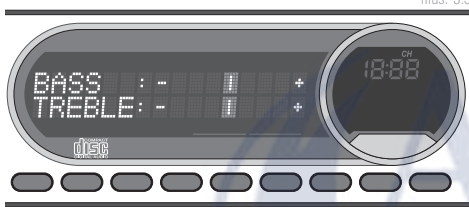

illus.-3.3

Step 4. Download test tones at https://rfttech.custhelp.com/app/answers/detail/a_id/1126/. Scroll to the bottom of the page and download your preferred format.

illus.-3.4

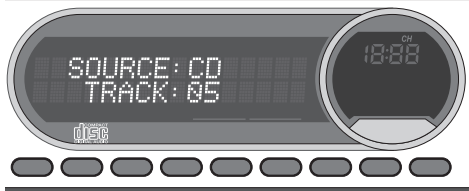

Note: Use the 40Hz @ 0dB tone (Track 5) for mono amplifier applications or the 1kHz @ 0dB tone (Track 7) for multi-channel amplifier applications. Be sure your x-over is switched to the appropriate filter setting.

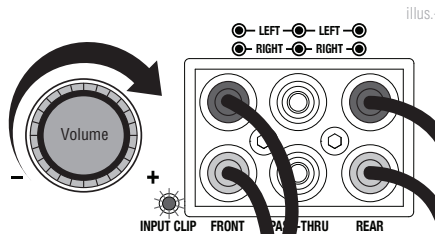

illus.-3.5

Step 5. Increase the source unit volume until the Input Clip Indicator illuminates red.

Note: Input Clip can be viewed remotely with optional PLC2.

Step 6. Decrease the source unit volume slightly until the light turns completely off. This establishes your maximum source unit volume for adjusting the Output Clip Indicator.

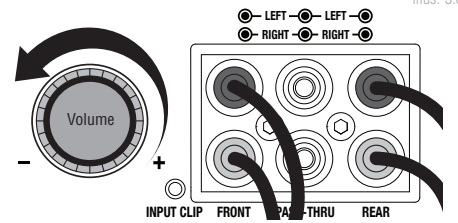

illus.-3.6

Note: Some source units will not clip.

Output Clip Indicator Setup

Step 7. Be sure to disconnect Punch Level Control - PLC (if equipped) from the amplifier.

Step 8. Adjust the Input Level knob until the Output Clip Indicator illuminates to the appropriate color. Repeat for all channel levels of input.

OUTPUT CLIP INDICATORS		
	MUSIC	TEST TONE*
BLUE	⊘	✓
BLUE/RED	✓	⊘
RED	⚠	⊘

*1kHz @ 0dB

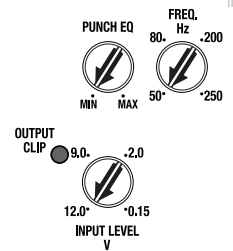

illus.-3.7

Step 9. Turn the source unit volume down.

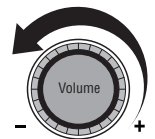

illus.-3.8

Step 10. Reconnect all speakers and Punch Level Control - PLC (if equipped) to the amplifier. Be sure to maintain proper speaker polarity.

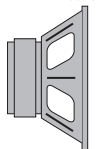

illus.-3.9

Adjusting Crossover Frequency

Do the following individually for each channel.

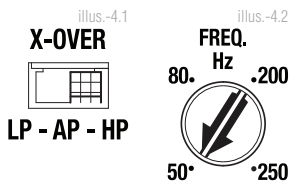

Placing the crossover switch in the HP position sets the amplifier to the High Pass mode, enabling frequencies above the cut-off point to pass, adjustable between 50-250Hz.

Placing the crossover switch in the AP position sets the amplifier to the All Pass mode, preventing any crossover adjustment, allowing all frequencies to pass.

Placing the crossover switch in the LP position sets the amplifier to the Low Pass mode, enabling frequencies below the cut-off point to pass, adjustable between 50-250Hz.

Turn the crossover adjustment knob all the way down. With the system playing, turn the crossover adjustment knob up slowly until the desired crossover point is achieved.

2/4 Channel Switch

Setting this switch to the 2CH. position, switches the inputs to a 2-channel mode, allowing connection to only the front inputs with a 4-channel output.



Output controls function the same as if the amplifier was in 4-channel mode.

All "ACTIVE" inputs must have RCA jacks connected.
 Switch in 2CH. position, "ACTIVE" - Front channel inputs only.
 Switch in 4CH. position, "ACTIVE" - All Front and Rear channel inputs.

NOTE: When connecting to the 4-Channel inputs, be sure to route both front and rear RCA cables tightly together.

Subwoofer Input Switch (PM1000X5)

Setting this switch to the Off position, utilizes the front inputs, allowing connection to only the front inputs with a subwoofer output. Setting this switch to the On position uses sub input.

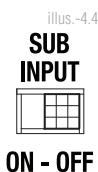

Output controls function the same as if the amplifier was in 5-channel mode.

All "ACTIVE" inputs must have RCA jacks connected.
 Switch in FRONT. position, "ACTIVE" - Front channel inputs only for sub output. Switch in SUB position, "ACTIVE" - Sub inputs for sub output.

NOTE: When connecting to the 5-Channel inputs, be sure to route front, rear and sub RCA cables tightly together.

High Level Input

Connect from source signal by plugging into the RCA input jacks at the amplifier. The input sensitivity ranges from 150mV-12V to accommodate signal from high-level(speaker) input. When utilizing high-level for input

signal the auto turn-on feature is active. With the auto turn-on active, the REM becomes an output to turn on/off up to two additional amplifiers or other accessories.

Pass Thru

The pass-thru RCA's are passive, including full input signal range and auto turn-on functionality when active. When utilizing Pass Thru jacks, up to two additional amplifiers can be connected together.

Infrasonic Filter

The 28Hz 12dB/octave infrasonic filter limits the amount of low frequency information going to the woofer.



NOTE: We recommend using the infrasonic filter when using vented enclosures with this amplifier.

Punch EQ

This works along with the crossover switch on the amplifier. When set to Low-Pass (LP) operation, this is a variable Bass Boost. When set to High-Pass (HP) operation, this is a variable Mid-Bass and Treble Boost. When set to All-Pass (AP) operation, both the Bass and Treble frequencies are boosted. Set this to your personal preference while listening to the system.

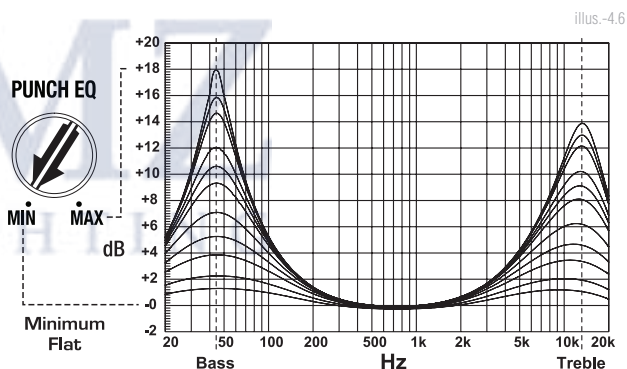

CAUTION Over excursion and subsequent damage may occur at high levels of boost.

Remote Punch Level Control (Option)

NOTE: Previous (prior to 2013) PEQ, Punch Bass and Para-Punch remotes will not work with these amplifiers.

Quick Install:

- Using the screws supplied, install the mounting clip.
- Slip the remote onto the mounting clip until it snaps into place.
- Route and connect the cable to the remote and amplifier.

Operation:

- When connected, the "Level Control" is linked and allows you to remotely control the output level of the amplifier from the dash or center console.

NOTE: Use the instructions that came with the remote for a variety of mountings that fit your preference.

Troubleshooting

Troubleshooting

NOTE: If you are having problems after installation follow the Troubleshooting procedures below.

Check Amplifier for proper connections. Verify that POWER light is on. If POWER light is on skip to Step 3, if not continue.

1. Check in-line fuse on battery positive cable. Replace if necessary.
2. Check fuse(s) on amplifier. Replace if necessary.
3. Verify that Ground connection is connected to clean metal on the vehicle's chassis. Repair/replace if necessary.
4. Verify there is 9 to 14.4 Volts present at the positive battery and remote turn-on cable. Verify quality connections for both cables at amplifier, stereo, and battery/fuseholder. Repair/replace if necessary.

Protect light is on.

1. If the Protect light is on, this is a sign of a possible short in the speaker connections. Check for proper speaker connections and use a volt/ohm meter to check for possible shorts in the speaker wiring. Too low of a speaker impedance may also cause Protect to light.

Check Amplifier for audio output.

1. Verify good RCA input connections at stereo and amplifier. Check entire length of cables for kinks, splices, etc. Test RCA inputs for AC volts with stereo on. Repair/replace if necessary.
2. Disconnect RCA input from amplifier. Connect RCA input from test stereo directly to amplifier input.

Check Amplifier if you experience Turn-on Pop.

1. Disconnect input signal to amplifier and turn amplifier on and off.
2. If the noise is eliminated, connect the REMOTE lead of amplifier to source unit with a delay turn-on module.

OR

1. Use a different 12 Volt source for REMOTE lead of amplifier.

Check Amplifier if you experience excess Engine Noise.

1. Route all signal carrying wires (RCA, Speaker cables) away from power and ground wires.

OR

1. Bypass any and all electrical components between the stereo and the amplifier(s). Connect stereo directly to input of amplifier. If noise goes away the unit being bypassed is the cause of the noise.

OR

1. Remove existing ground wires for all electrical components. Reground wires to different locations. Verify that grounding location is clean, shiny metal free of paint, rust etc.

OR

1. Add secondary ground cable from negative battery terminal to the chassis metal or engine block of vehicle.

OR

1. Have alternator and battery load tested by your mechanic. Verify good working order of vehicle electrical system including distributor, spark plugs, spark plug wires, voltage regulator etc.

Remote not functioning.

1. BD amplifiers remote switch in "ON" position.

OR

2. Remote plugged into remote PLC "IN" port

Remote Lights not functioning.

1. Remote plugged into remote PLC "IN" port

Rockford Corporation offers a limited warranty on Rockford Fosgate products on the following terms:

Length of Warranty

- POWER Amplifiers – 2 Years
- BMW® Direct Fit Speakers – 2 Years
- PUNCH® & PRIME® Amplifiers – 1 Year
- Speakers, Signal Processors, Accessories and Capacitors – 1 Year
- All marine, motorcycle, motorsport products - 2 Years
- Any Factory Refurbished Product – 90 Days (receipt required)

What is Covered

This warranty applies only to Rockford Fosgate products sold to consumers by authorized Rockford Fosgate dealers in the United States of America. Products purchased by consumers from an Authorized Rockford Fosgate Dealer in another country are covered only by that country's Distributor and not by Rockford Corporation.

Who is Covered

This warranty covers only the original purchaser of Rockford product purchased from an authorized Rockford Fosgate dealer in the United States. In order to receive service, the purchaser must provide Rockford with a copy of the receipt stating the customer name, dealer name, product purchased and date of purchase.

Products found to be defective during the warranty period will be repaired or replaced (with a product deemed to be equivalent) at Rockford's discretion.

What is Not Covered

1. Damage caused by accident, abuse, improper installation, operations, theft, water (on non-Element Ready products).
2. Any cost or expense related to the removal or reinstallation of product.
3. Service performed by anyone other than Rockford or an authorized Rockford Fosgate service center.
4. Any product which has had the serial number defaced, altered, or removed.
5. Subsequent damage to other components.
6. Any product purchased outside the U.S.
7. Any product not purchased from an authorized Rockford Fosgate dealer. Refer to rockfordfosgate.com dealer locator for more detail.

Limit on Implied Warranties

Any implied warranties including warranties of fitness for use and merchantability are limited in duration to the period of the express warranty set forth above. Some states do not allow limitations on the length of an implied warranty, so this limitation may not apply. No person is authorized to assume for Rockford Fosgate any other liability in connection with the sale of the product.

How to Obtain Service

Please call 1-800-669-9899 for Rockford Customer Service. You must obtain an RA# (Return Authorization number) to return any product to Rockford Fosgate. You are responsible for shipment of product to Rockford.

EU Warranty

This product meets the current EU warranty requirements, see your Authorized dealer for details.

Installation assistance available at:

RFTECH

www.rockfordfosgate.com/rftech

